

FRONT VIEW

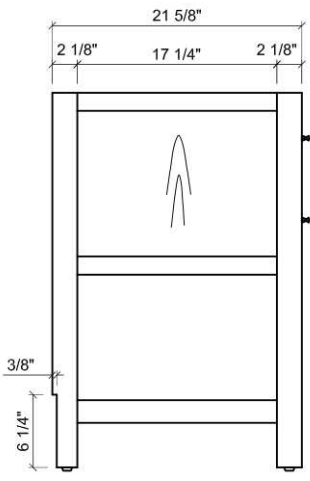

SIDE VIEW

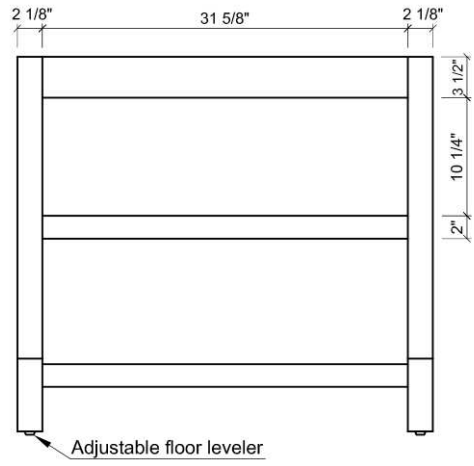

BACK VIEW

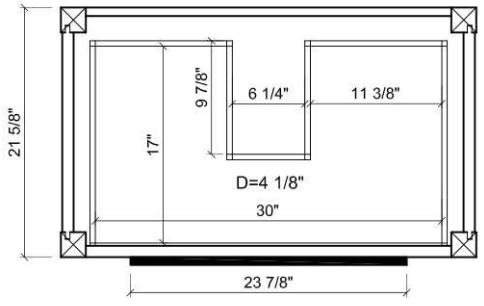

TOP VIEW

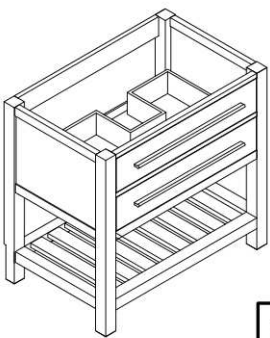

Empire Industries	Project: PRIVA
Item: PRIVA 36" (1 of 2)	Date: 2010-09-15

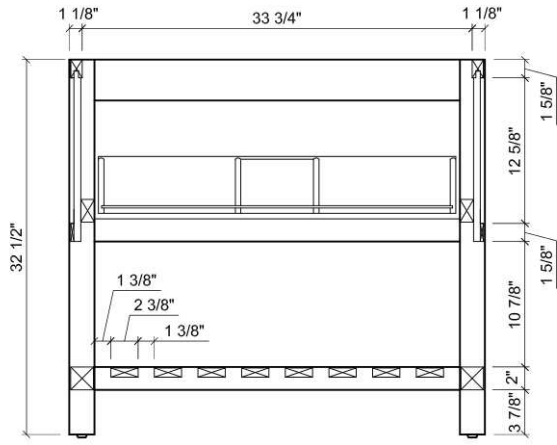

SECTION A-A

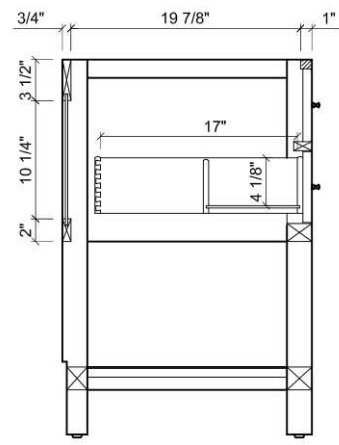

SECTION B-B

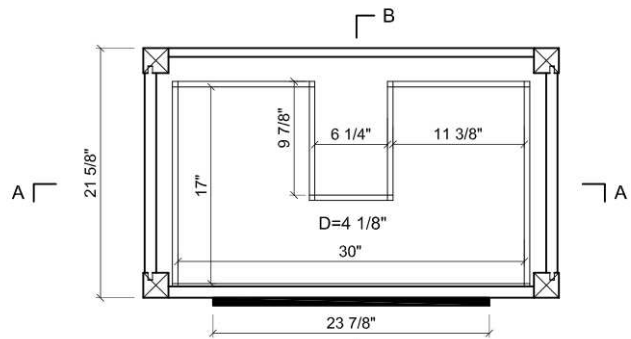

TOP VIEW

Empire Industries	Project: PRIVA
Item: PRIVA 36" (2 of 2)	Date: 2010-09-15